



NEW

UNIQUIN

The access and room system with lifestyle character

UNIQUIN, the versatile access and room system for enhanced interior architecture.

glass **V**irginia mirror

dormakaba 

Contents



03 **Intelligent design**
Visually attractive,
solid construction



04 **Smart spatial
planning**
From sound
insulation
to electrification



06 **Application
adaptability**
From hotels to
fitness suites



08 **Compelling benefits**
For architects and
installers



09 **Technical data**
Dimensions, weights,
drawings



14 **Optional
components**
Locks, door closers
and more

The ideas man

UNIQUIN was conceived by Hubert Elmer. The lateral thinker from Austria has already made a name for himself in architecture and interior design. His MANET product design has won numerous awards and, with its striking aesthetic appeal, also proven highly popular in practice. Now, Elmer has developed

a multifunctional profile system for room configuration and access applications that appeals on both the visual and the structural level. Combining his extensive experience with a keen appreciation of evolving user requirements, he has joined a number of innovative ideas into a single concept: UNIQUIN.



Hubert Elmer, inventor of UNIQUIN, lives and works in Innsbruck, Austria

“My goal was to create a profile system that impresses through its light yet uniform appearance, while at the same time being easy to configure and install.” **Hubert Elmer**

Elements with a single identity

UNIQUIN enhances your interior architecture. The system made in Germany comprises flush-fitting profiles complemented by architectural hardware and locking systems in the same coordinated design. A special powder coating is

the aluminum, delivering an elegantly textured finish that offers effective mechanical resistance. UNIQUIN can be fitted with partition elements of glass, timber or other materials in thicknesses between 10 and 19 mm.



Coordinated, elegant design from the frame to the lever handle



Sliding doors can also be effortlessly integrated



You can combine other dormakaba components such as the TS 97 door closer

Award-winning design



UNIQUIN recognized with the Iconic Award.

The internationally renowned German Design Council awards this honor to visionary buildings, innova-

tive products and sustainable communication from all segments of architecture, the construction and realty sectors and the manufacturing industries.



UNIQUIN

The system for communicative room designs

glass **V**irginia
mirror

01

Sliding door

Create access points without losing space. With UNIQUIN you can incorporate single or double-panel sliding doors with ease.

02

Room-height single-action door

Incorporate door systems measuring up to 3 meters in height. These prestigious access points create a striking impression.

03

Corners

Interconnect your rooms with elegant 90-degree corners to eliminate disruptive vertical posts and thus create more transparency.

04

Electrification

With the aid of special mounting elements, you can position switches and sockets in door frame profiles. Integrated cabling ensures an elegant connection to the power circuit every time.



Enhance your interior architecture. The system comprises partitions and door solutions that offer coordinated, attractive design coupled with impressive application versatility. For effortlessly combined transparency and discretion: UNIQUIN.

05

Acoustic module

The acoustic modules from UNIQUIN absorb sound waves from within to create a pleasant ambient feel. The fabric covering can be individually printed and backlit*. Whether it's an eye-catching detail or discreet background – you decide.

06

Sound protection

More transparency, less noise. The decoupled mountings for the glass elements in the profile, combined with sound insulation glass (LSG with sound protection laminate), reduce sound transmission.

07

Single-action door

Whether doors of glass for elegance or timber for selective visual privacy, again, the choice is yours. The profile system will hold your chosen material in thicknesses between 10 and 19 mm.

08

Door assemblies in structural openings

You can also use the frame profiles from UNIQUIN for classic single-door solutions, giving a uniform, coordinated look throughout the entire building.

* Concept and installation by others

One system, many purposes



Transparent: Rooms created with UNIQUIN are bright and friendly.

Relaxation areas such as **lounges or workplace rest areas** are given a new, communicative atmosphere with UNIQUIN: glass walls combined with attractive design from UNIQUIN create open and enticing spaces.

Acoustically separated from the hustle and bustle, they nevertheless remain integrated within the whole of your interior. The system allows everyone to find the peace of mind they need to relax while staying close to the action.



The frame system from UNIQUIN is suitable both for rooms where full transparency is desirable and for individual door solutions. Timber variations, for example, provide visual interest plus discreet privacy where it is required.

Conference rooms should be focal points for focused and creative work, to which transparency need be no hindrance. Quite the contrary: an open room with natural daylight penetration and a wide panorama create a pleasant and motivating atmosphere. This also helps in

those decisive moments when thoughts need to be gathered and ideas allowed to mature. With UNIQUIN, conference rooms benefit from reduced inward and outward sound transmission, helping to promote productivity and creativity.

Divides space without filling it



UNIQUIN offers particular benefits when it comes to efficiently harnessing space and natural light, for example in hotels. Harmonious: the UNIQUIN pull handle offers a seamless match with the design concept, offering uniformity in both color and shape.

Great in small spaces

UNIQUIN's strengths come to the fore wherever limited space needs to be utilized with maximum efficiency. The system enables the available area to be effectively structured while keeping all sections interconnected – so maintaining that feeling of spaciousness. In a hotel

room, guests can experience the space in its entirety – regardless of where they are within the suite. With UNIQUIN, divided spaces appear to gain size, light and ambience, increasing the feeling of luxury and wellbeing.



With its open design, UNIQUIN scores highly wherever a view into neighboring rooms is desirable – for example in fitness suites. Plus, the fabric of the acoustic modules can be individually printed, offering visual highlights as well as enhancing the ambient feel of the space.

Large rooms visually united but acoustically separated

With UNIQUIN, you create rooms that offer advantages in virtually any application. The modular system enables you to divide areas without limiting the free, wide panorama and extensive access to natural light. In terms of color, UNIQUIN's anthracite finish fits almost any environment.

The ambient feel can be greatly enhanced by the use of acoustic modules. These reduce sound transmission, as does the decoupled mounting system for the glass elements in the UNIQUIN profiles, making UNIQUIN a universal solution for almost all types of room usage.

UNIQUIN

Enhance your interior architecture.

For designers who prefer to set their own boundaries.

UNIQUIN is an excellent option for architects, building services planners and interior designers when consulting clients on a concept that suits their needs.

With UNIQUIN you can develop spatial designs that stand out in terms of both quality and flexibility. The flush-fitting elements, with their slender styling, exude excellence in both material and workmanship. The profiles can be used to install both glass and materials such as timber, all in thicknesses of between 10 and 19 mm. This allows you to adopt your own, harmonious mix of transparent and opaque elements, combining panoramic views with discreet privacy at your discretion.



UNIQUIN offers a high level of flexibility in room configuration.

Great scope in satisfying project requirements

- Planning variability
- All components of coordinated design
- Sound reduction indices up to 40 dB within the integrated system
- Aluminum profiles with special powder coating offering effective mechanical resistance
- Suitable for installing glass or other materials up to 19 mm in thickness
- All components available for ordering within the same system

Got a design-related or specific technical question?

Then please get in touch: www.glas-innovationen.com/contact

For installers who appreciate uncomplicated quality.

Whether you are a specialist firm or contractor, with UNIQUIN you can be sure of completing your interior outfitting project with all trades properly coordinated.

UNIQUIN enables fast and easy implementation of fully integrated spatial concepts. The system can be readily installed with standard tools in rooms of all the usual heights up to 4,000 mm. The component connections are fully coordinated and requisite cabling can be ducted through the profiles to give further flexibility. The profiles are available for delivery either in stock lengths or custom-cut – just let us know your specifications when placing the order.



Easy to install thanks to accurately machined and fabricated system components that interconnect effortlessly.

Beautifully simple

- Installation with standard tools
- Coordinated construction connections
- Easy to repair, reconfigure or dismantle and re-install
- Standard room heights accommodated without problem
- Profiles delivered from the factory in the required length
- Problem-free integration of electrical connections
- Effective trade coordination possible – e.g. electrical installation work during final fitting of the cover profiles

Technical data of the UNIQUIN components

With UNIQUIN, you can create an interior design exactly to your taste – from comprehensive room concept to individual door solution. On the following pages, you will

find an overview of the individual system elements, technical details and drawings to assist you in your planning.



Maximum installation heights

Glass thickness (mm)	Glass type	Max. height (mm)
10	LSG	2,800
12	LSG	3,000
13	LSG	2,500
13.5	LSG	2,500
15	LSG	4,000
17	TSG	4,000
17.5	TSG	4,000
19	TSG	4,000

We are happy to provide you with a general structural stability calculation based on maximum values. For your contact person go to glas-innovationen.com/contact.

Technically, almost anything is possible – UNIQUIN from dormakaba

Technical data – Mounting profiles and fixed elements

Profile material	Aluminum, powder-coated	Installation measurements	w = no limit (according to respective glass statics) h = max. 4,000 mm
Profile color	Graphite, scratch-resistant	Structural analysis	Structural stability calculation according to DIN 18008 / DIN 4103
Glass / timber installation	Glass (10–19 mm, TSG, LSG of 2 x TSG)	Emergency escape / panic function	According to EN 179 and EN 1125 (can be equipped optionally)
Installation options	Wall, floor, ceiling, inside and outside corners, T-joint	Fixed glass element Rim glass element	w = min. 500 mm, h = max. 4,000 mm w = min. 300 mm, h = max. 4,000 mm
Electrification	Integrated cabling of NYM cables with max. outside diameter of 10 mm	Mounting profile	46 mm profile height, 10–13.5 mm 46 mm profile height, 14–18 mm 55 mm profile height, 16–19 mm
Sound insulation	Tested sound protection according to DIN EN ISO 10140 up to 41 dB, depending on design and construction type	Door types	Single-action and manual sliding doors

All the components at a glance

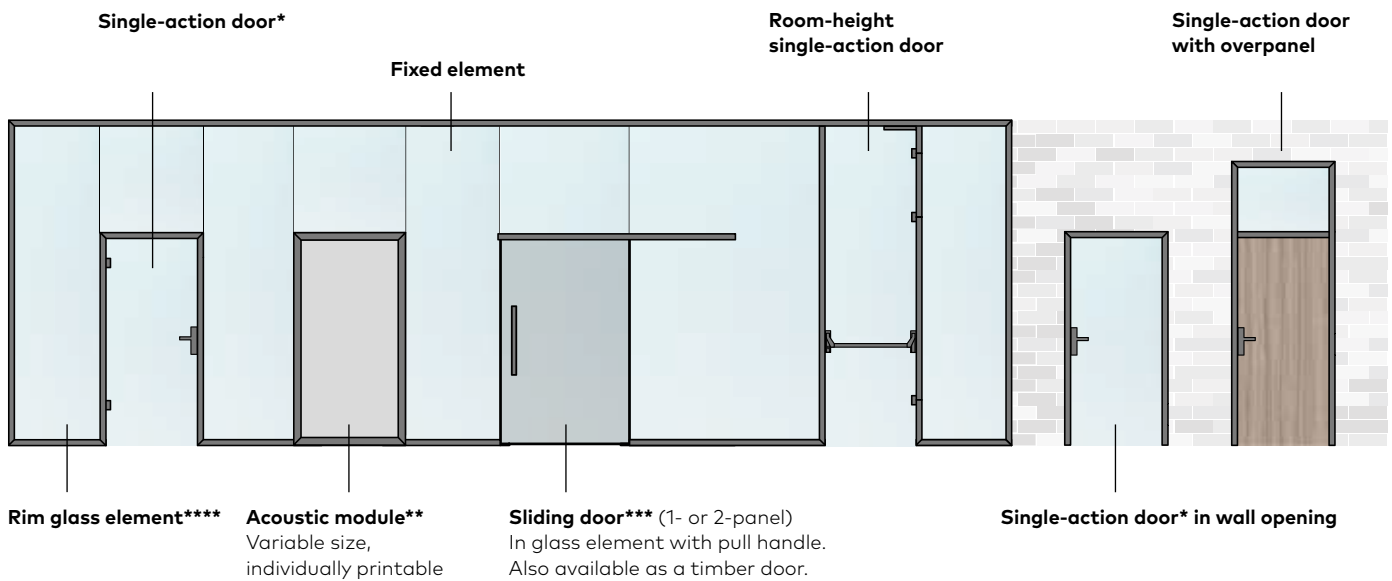

* **Scope of supply door:** Frame element, hinges, standard lock (europrofile cylinder), lever handle

** **Scope of supply acoustic module:** Frame profile, acoustic foam (optional), internal anti-penetration barrier (optional), decorative fabric cover/lighting by others

*** **Scope of supply sliding door:** Complete system comprising UNIQUIN/MUTO L80

**** For details please see table on page 9

Mounting profiles and fixed element data



The mounting profiles form the basis of the UNIQUIN system. There are three types to facilitate optimal installation of single-panel toughened and laminated safety glass (of TSG) and alternative materials, all with thicknesses from 10 to 19 mm. The 55 mm high profile offers plenty of scope for evening out structural tolerances, particularly in conjunction with thick infill materials. The silicone beading decouples the glass from the profile, as well as the profile from the structural substance of the building. The profile interior can incorporate cables with cross sections of up to 10 mm.

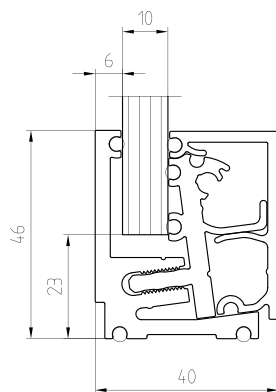

46 mm profile height
10–13.5 mm glass

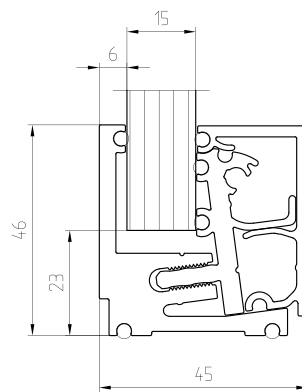

46 mm profile height
14–18 mm glass

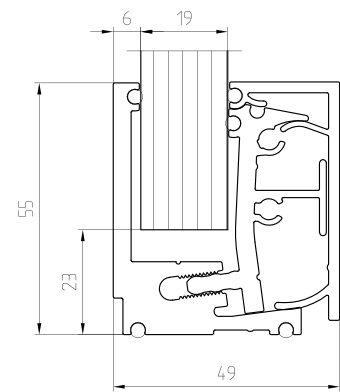

55 mm profile height
16–19 mm glass

90° corner and T-joint connections

Attention: In direct connection with doors, bendings such as 90° external corners and T-joint connections are not possible. Cuttings are to be made by others.

Recommendation: Please order profiles in excess length.

90° external corners

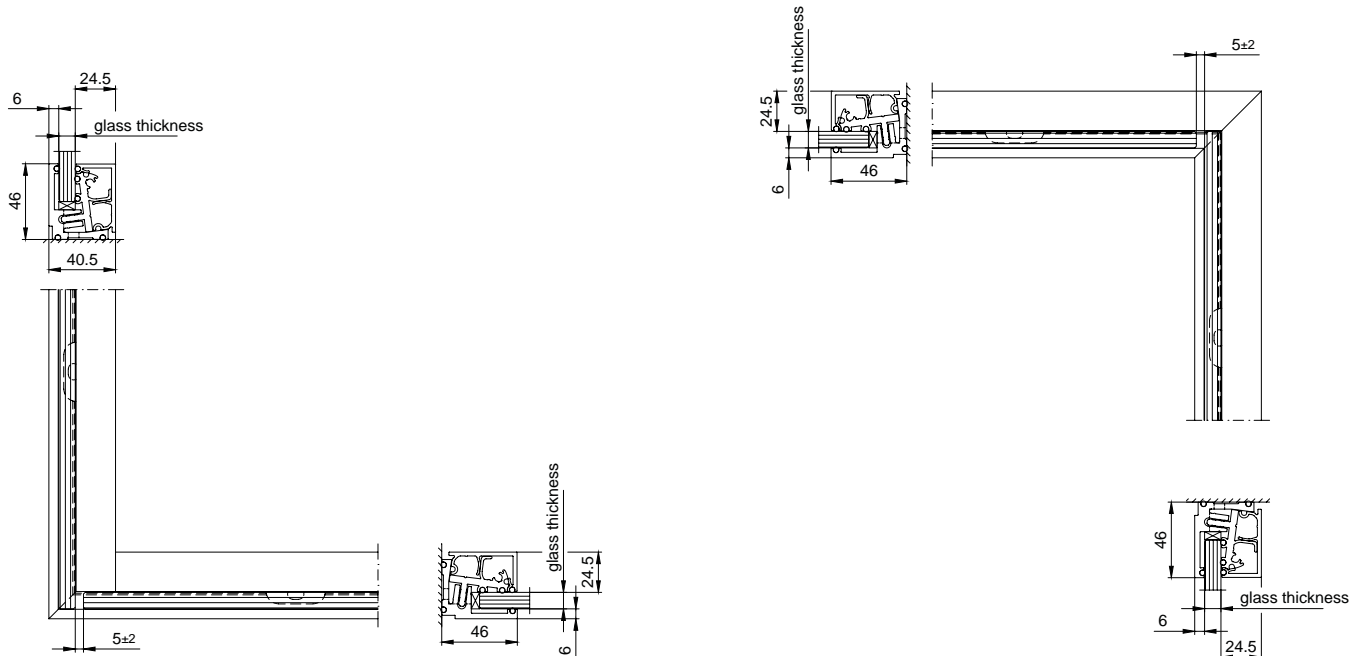

Base profile outside with mitre joint,
cover profile inside with butt joint

Base profile inside with mitre joint,
Cover profile outside with mitre joint

90° T-joint connections

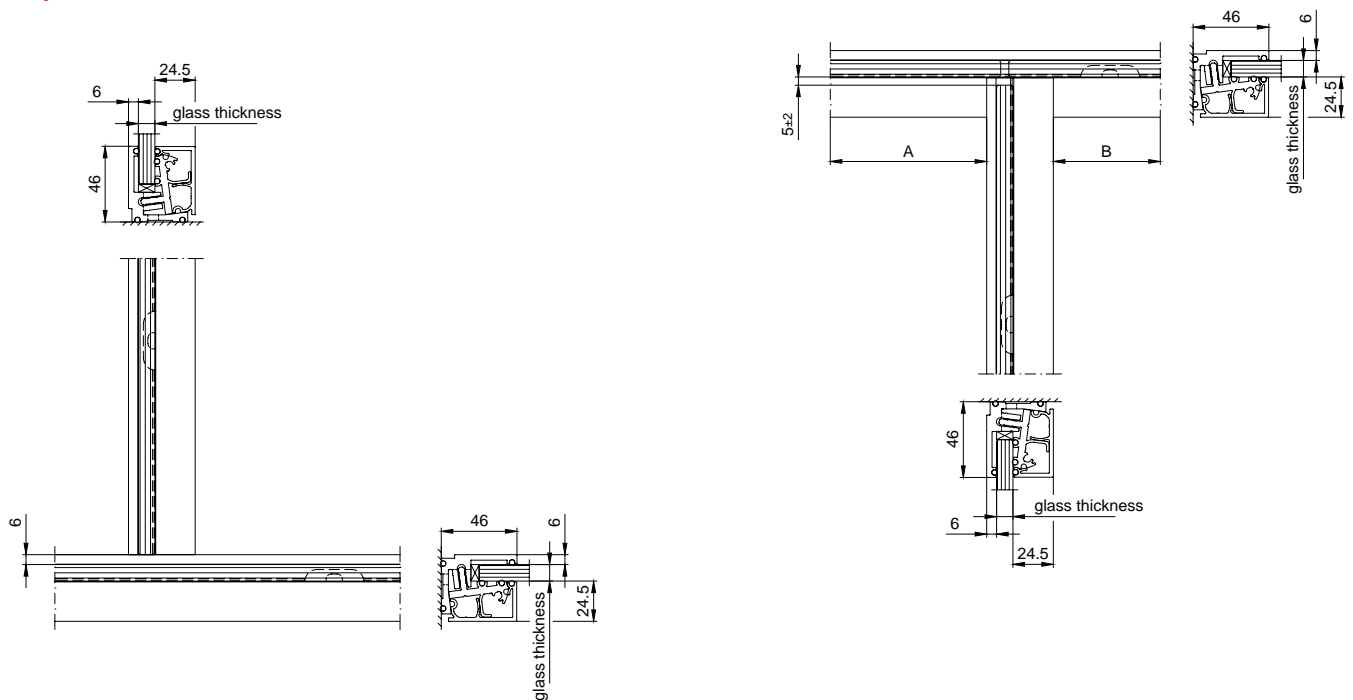

On the side of the base profile

On the side of the cover profile

Find further drawings regarding the UNIQUIN system, an overview of articles, the possible glass thicknesses as well as the position of the glass clamping pieces online on compendium2.glas-innovationen.com.

Frame elements in wall opening

With UNIQUIN you can also effortlessly implement individual door solutions in the structural wall openings. For this form of installation, we again offer three different frame sizes.

Maximum door weight including all fittings: 130 kg

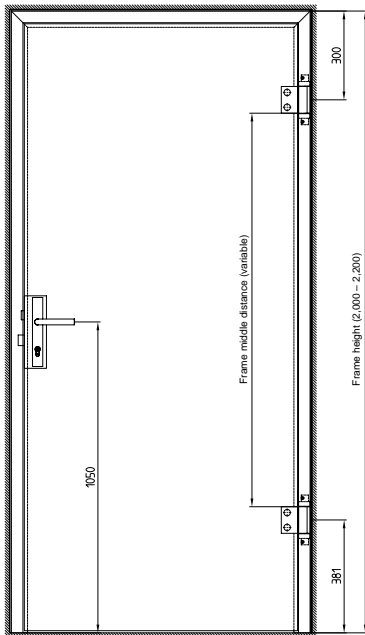

Size 1: 2 hinges
Height: 2,000–2,200 mm
Width: 1,010–1,186 mm

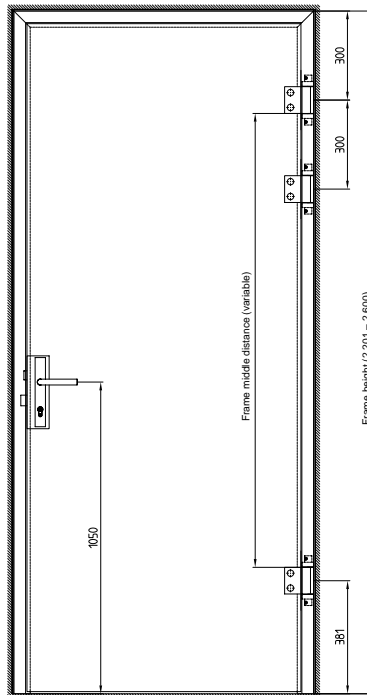

Size 2: 3 hinges
Height: 2,201–2,600 mm
Width: 1,010–1,186 mm

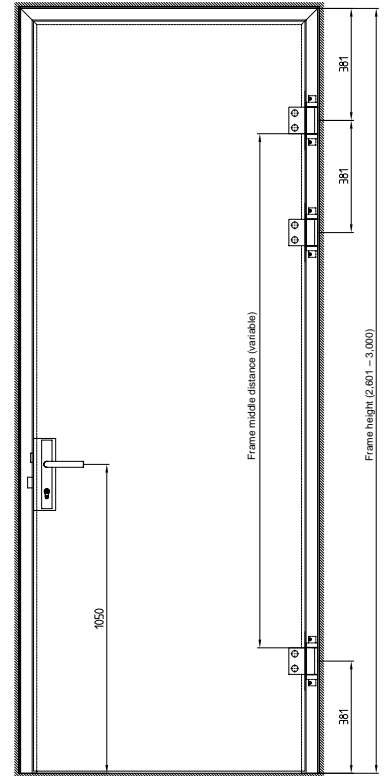

Size 3: 3 hinges
Height: 2,601–3,000 mm
Width: 1,010–1,186 mm

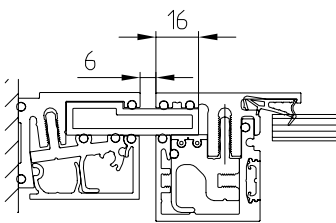

Frame installation type 1
With direct connection to the base profile (facilitates combination with glass overpanel)

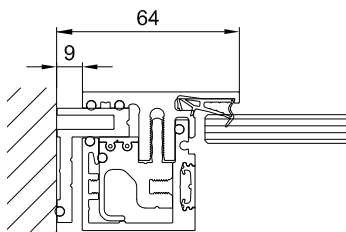

Frame installation type 2
Direct abutment with the wall opening using an adapter profile (depending on the installation, the door opening may be limited to approx. 90°)

Sliding door MUTO L 80 on glass

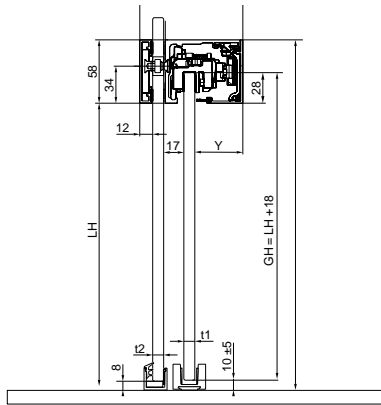

MUTO L 80

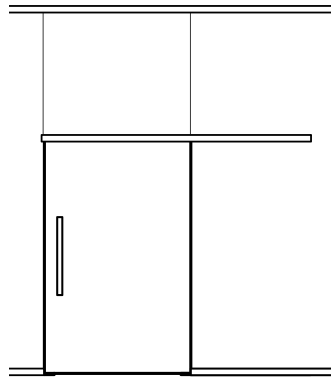

MUTO L 80 with handle bar

The sliding door element holds the infill of glass or timber. The thickness of the elements in the case of the glass version may range from 8 to 13.5 mm, while the timber infill version can range from 28 to 50 mm.

Please note: By design, sliding doors do not have the same high sound protection values as partitioning systems and single-action doors.

Technical data – single-action and manual sliding doors

	Single-action doors	Manual sliding doors
Glass thickness	10–19 mm	8–13.5 mm
Timber width	40–50 mm	28–50 mm
Max. panel weight	Glass door: 130 kg Timber door: 80 kg	80 kg
Max. frame / profile height	3,000 mm	3,000 mm
Max. panel width	1,100 mm	2,000 mm
Min. panel width	660 mm 710 mm (with drop-down seal)	660 mm
Operating cycles	200,000	100,000
Corrosion resistance per EN 1670	Class 2	Class 4
Locking	Mortise locks according to DIN 18251-2, Backset 45 mm Center distance 92 mm	Integrated locking (optional / retrofittable)
Emergency exit	According to EN 179, EN 1125	
Door closer	TS 97 (glass) ITS 96 (timber)	
Further components (optional / retrofittable)		DORMOTION damping, integrated status indicator

Optional components

Locks



Standard lock / panic lock with europrofile cylinder

Electronic door fitting
dormakaba c-lever compact

Emergency exit pushbar assembly

Door components



For glass doors:
TS 97

For timber doors:
ITS 96



Mounting box
For power sockets and switches

Drop-down seal

Acoustic modules

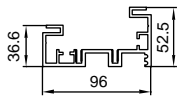

Profile acoustics / ad retainer (A)
Weight: 2.447 kg/m

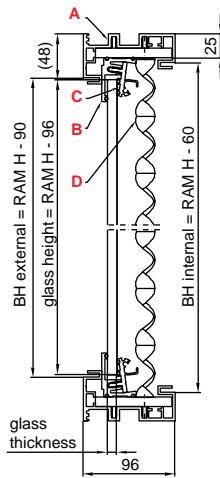

Base profile 46 (B)
10–13.5 mm glass,
14–18 mm glass,
each incl. **glass clamping
piece (C)** + seal
**Please calculate with 3 glass
clamping pieces per 1,000 mm
base profile.**

- A = Profile acoustics / ad retainer
- B = Base profile
- C = Glass clamping piece
- D = Convoluted foam sound absorption panel

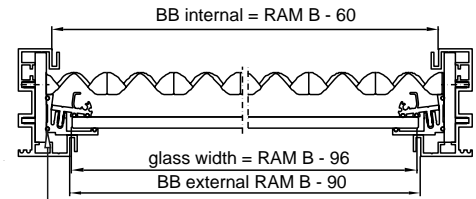
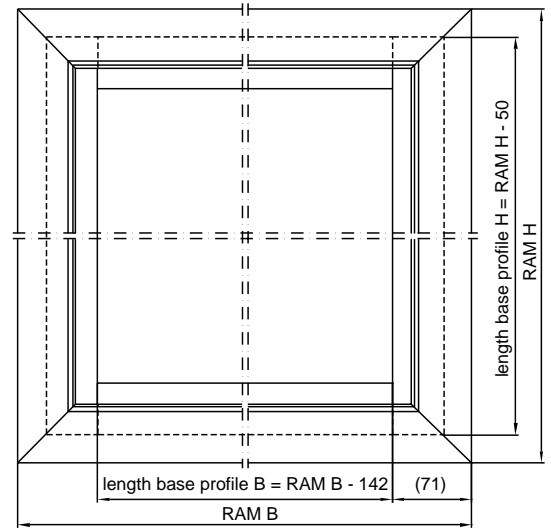

2 spacer per 1,000 mm base profile

Convoluted foam sound absorption panel (D)
Format: 1,000 x 500 x 40 mm
one-sided self-adhesive
Flame protection DIN 4102
Necessary amount equals glass surface.

- BB: Fabric cover width
- BH: Fabric cover height
- RAM: External frame

Fabric cover

To absorb sound waves, the acoustic image with a special structure is applied on to the convoluted foam. If only a one-sided absorption is required, an advertisement cover can be tensioned on the second side. The purchasing of the textiles is carried out by others.

Acoustic image

For sound absorption please use the acoustic image combined with the convoluted foam sound absorption panel (D).

Material: Textile Trevira CS 300g/m² white, one-sided or double-sided printed all around flat silicone welting 15 mm x 2.8 mm for frames

Advertisement cover

Material: Deco light or Dynajet white, one-sided or double-sided printed all around flat silicone welting 15 mm x 2.8 mm for frames